

## GGT SERIES VIBRATION ISOLATORS

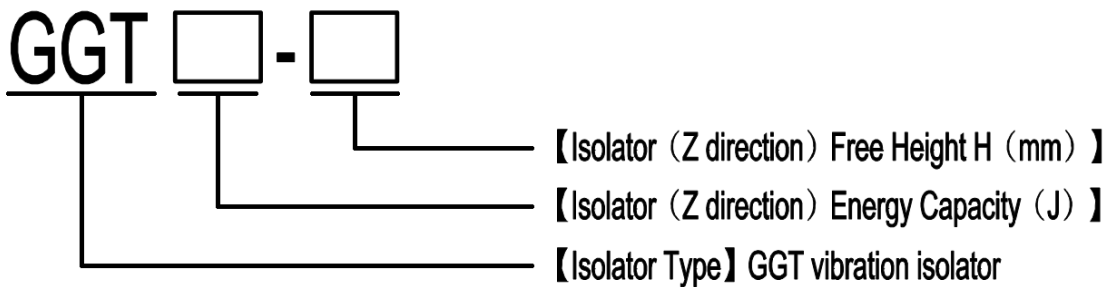

### Model Description



### NOTES:

- All dimensions are metric (mm).
- Material for retainer bars is 304 stainless steel, wire ropes are 304 stainless steel, and inserts (if with) are 304 stainless steel.
- Operating temperature range:  $-100^{\circ}\text{C} \sim +250^{\circ}\text{C}$ .
- Standard product mounting holes are metric.
- Specials available upon request.

### Technical Data:

Address: Shuang Xin Industrial Park, TaiHu Town,  
WuXi, P. R. China

Post Code: 214125

Phone: (86-0510) 85192826 85190626

Fax: (86-0510) 85192826 85190626

E-mail: trade@dpflex.com daping369@163.com

Website: <http://www.dpflex.com>

**WUXI HONGYUAN DEVFLEX CO., LTD**

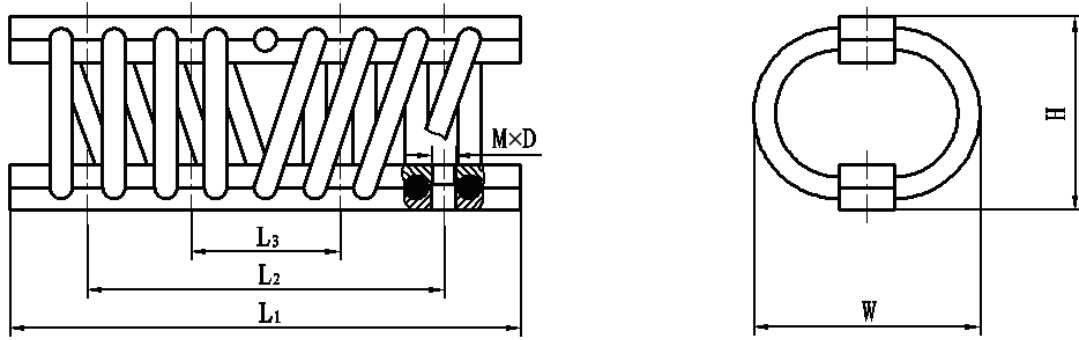
**Product Dimensions:**

Model	L1 (mm)	L2 (mm)	L3 (mm)	Width W (mm)	Height H (mm)	Mounting Holes M×D	Weight (kg)
GGT44-54	146	102		64	54	4×M8	0.6
GGT53-59				71	59		0.63
GGT48-64				80	64		0.67
GGT44-65				89	65		0.68
GGT72-71	216	156	66	84	71	8×M8	1.71
GGT79-75				90	75		1.75
GGT86-76				105	76		1.79
GGT83-83				108	83		1.85
GGT270-90				105	90		2.55
GGT270-95				121	95		2.75
GGT270-108				133	108		2.96
GGT430-99	268	192	82	112	99	8×M10	4.3
GGT500-109				135	109		4.5
GGT550-119				152	119		4.9
GGT1200-159	370	268	114	178	159	8×M16	13
GGT1300-191				210	191		15

Address: Shuang Xin Industrial Park, TaiHu Town,  
WuXi, P. R. China

Post Code: 214125

Phone: (86-0510) 85192826 85190626

Fax: (86-0510) 85192826 85190626

E-mail: trade@dpflex.com daping369@163.com

Website: <http://www.dpflex.com>

**WUXI HONGYUAN DEVFLEX CO., LTD**

## GGT05 Series Static Load — Deflection Charts:

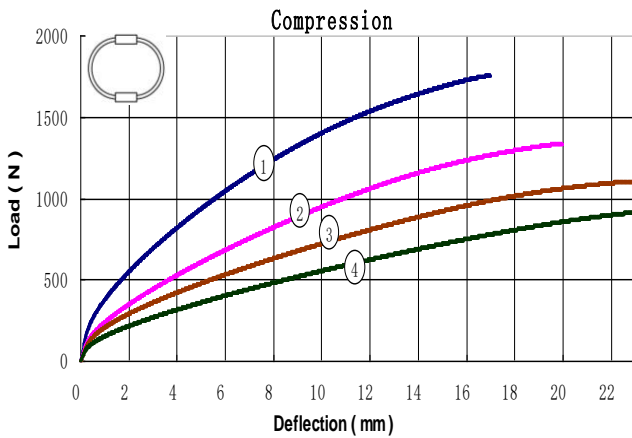

## Compression:

Model	*Load (kg)	**Static Stiffness (N/mm)	Max. Deflection (mm)	Max. Static Load (kg)
GGT44-54	56.4	154.6	17	179
GGT53-59	35.9	100.7	20	136
GGT48-64	30.1	74.8	23	112
GGT44-65	22.3	56.6	23	93

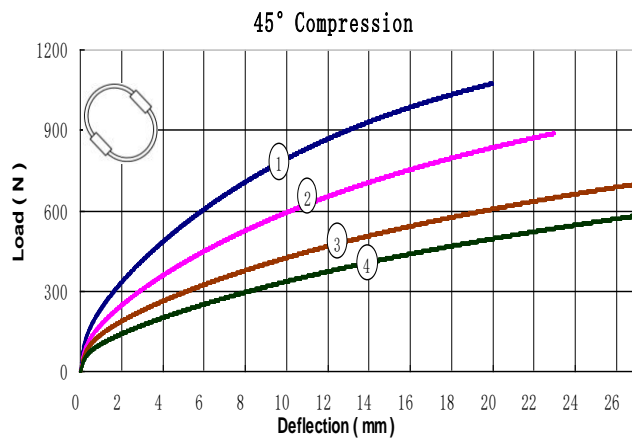

## 45° Compression:

Model	*Load (kg)	**Static Stiffness (N/mm)	Max. Deflection (mm)	Max. Static Load (kg)
GGT44-54	34.1	86.5	20	109
GGT53-59	25.2	62.7	23	90
GGT48-64	19.2	43.5	27	71
GGT44-65	14.1	34.1	27	59

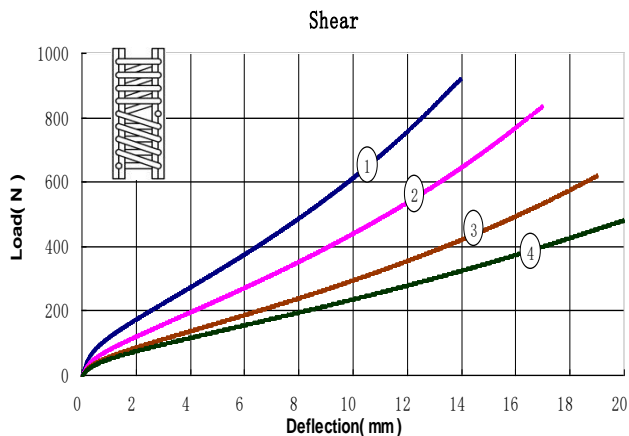

## Shear:

Model	*Load (kg)	**Static Stiffness (N/mm)	Max. Deflection (mm)	Max. Static Load (kg)
GGT44-54	17.7	50.2	14	93
GGT53-59	12.3	38.7	17	85
GGT48-64	8.9	26.3	19	63
GGT44-65	7.7	23.1	20	49

**NOTES:** \* Load --- Static nominal load at 2mm deflection.

\*\* Average Static Stiffness --- Static stiffness at 2mm deflection.

Address: Shuang Xin Industrial Park, TaiHu Town,  
WuXi, P. R. China

Post Code: 214125

Phone: (86-0510) 85192826 85190626

Fax: (86-0510) 85192826 85190626

E-mail: trade@dpflex.com daping369@163.com

Website: <http://www.dpflex.com>

**WUXI HONGYUAN DEVFLEX CO., LTD**

## GGT06 Series Static Load — Deflection Charts:

### Compression:

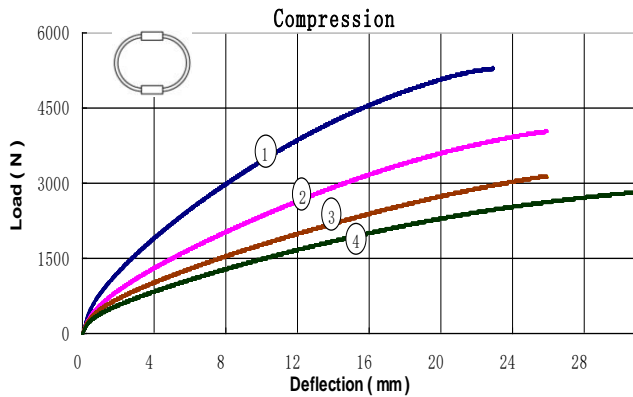

Model	*Load (kg)	**Static Stiffness (N/mm)	Max. Deflection (mm)	Max. Static Load (kg)
GGT72-71	125.6	376.1	23	539
GGT79-75	88.3	254.1	26	411
GGT86-76	71.5	182.1	26	320
GGT83-83	57.8	153.3	31	287

### 45° Compression:

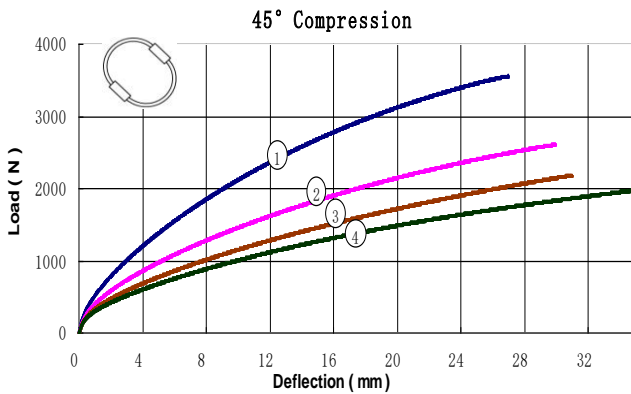

Model	*Load (kg)	**Static Stiffness (N/mm)	Max. Deflection (mm)	Max. Static Load (kg)
GGT72-71	80.5	237.9	27	362
GGT79-75	60.1	158.8	30	266
GGT86-76	48.7	121.2	31	222
GGT83-83	43.3	104.8	35	202

### Shear:

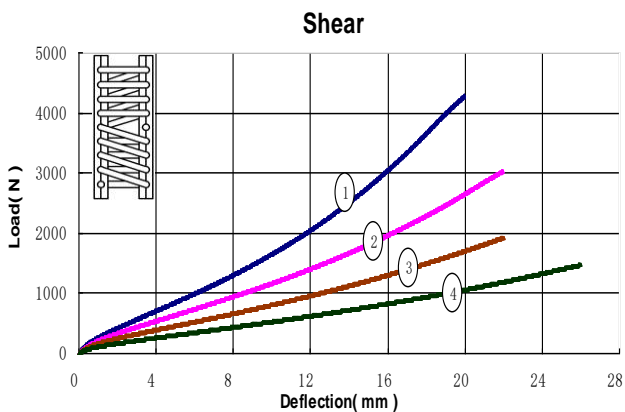

Model	*Load (kg)	**Static Stiffness (N/mm)	Max. Deflection (mm)	Max. Static Load (kg)
GGT72-71	43.1	146.6	20	436
GGT79-75	34.3	111.1	22	309
GGT86-76	25.9	76.3	22	196
GGT83-83	17.1	49.5	26	150

**NOTES:** \* Load --- Static nominal load at 2mm deflection.

\*\* Average Static Stiffness --- Static stiffness at 2mm deflection.

Address: Shuang Xin Industrial Park, TaiHu Town,  
WuXi, P. R. China

Post Code: 214125

Phone: (86-0510) 85192826 85190626

Fax: (86-0510) 85192826 85190626

E-mail: trade@dpflex.com daping369@163.com

Website: <http://www.dpflex.com>

**WUXI HONGYUAN DEVFLEX CO., LTD**

## GGT07 Series Static Load — Deflection Charts:

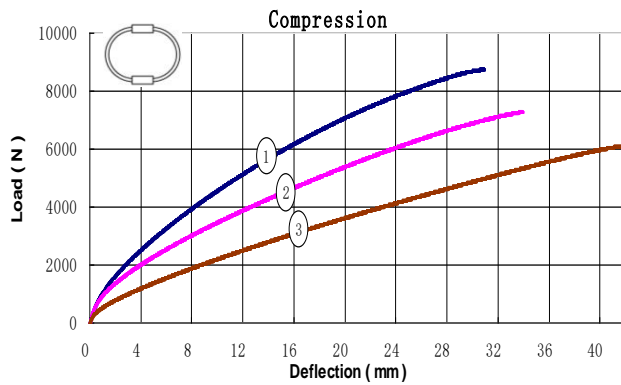

### Compression:

Model	*Load (kg)	**Static Stiffness (N/mm)	Max. Deflection (mm)	Max. Static Load (kg)
GGT270-90	166.1	504.5	31	892
GGT270-95	140.2	367.4	34	743
GGT270-108	80.2	223.8	42	623

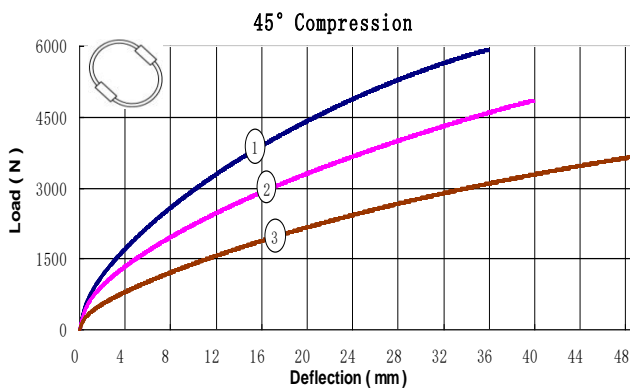

### 45° Compression:

Model	*Load (kg)	**Static Stiffness (N/mm)	Max. Deflection (mm)	Max. Static Load (kg)
GGT270-90	118.4	322.2	36	604
GGT270-95	95.8	238.8	40	494
GGT270-108	55.9	146.4	49	374

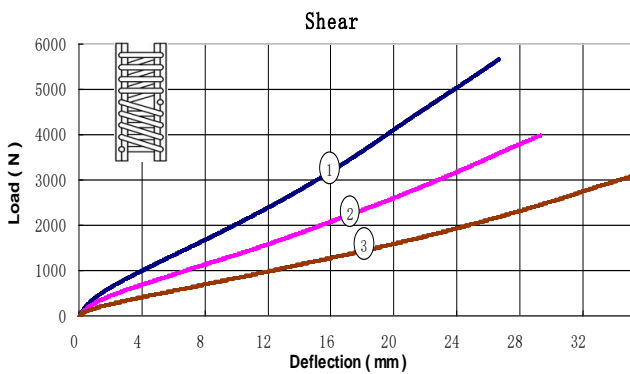

### Shear:

Model	*Load (kg)	**Static Stiffness (N/mm)	Max. Deflection (mm)	Max. Static Load (kg)
GGT270-90	65.5	207.6	26	578
GGT270-95	46.6	138.9	29	406
GGT270-108	27.1	81.9	35	316

**NOTES:** \* Load --- Static nominal load at 2mm deflection.

\*\* Average Static Stiffness --- Static stiffness at 2mm deflection.

Address: Shuang Xin Industrial Park, TaiHu Town,  
WuXi, P. R. China

Post Code: 214125

Phone: (86-0510) 85192826 85190626

Fax: (86-0510) 85192826 85190626

E-mail: trade@dpflex.com daping369@163.com

Website: <http://www.dpflex.com>

**WUXI HONGYUAN DEVFLEX CO., LTD**

## GGT08 Series Static Load — Deflection Charts:

### Compression:

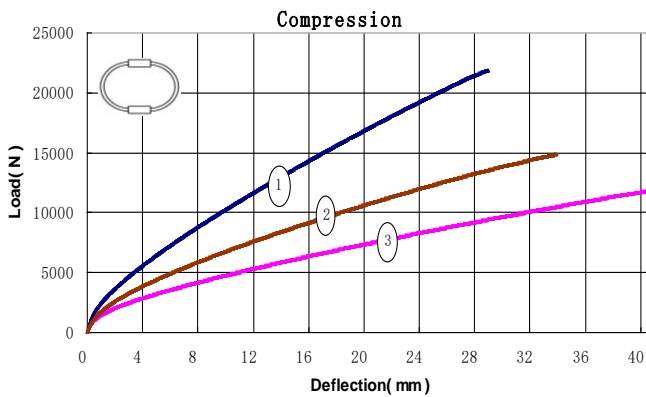

Model	*Load (kg)	**Static Stiffness (N/mm)	Max. Deflection (mm)	Max. Static Load (kg)
GGT430-99	374	1068	29	2228
GGT500-109	265	726	34	1516
GGT550-119	207	490	41	1221

### 45° Compression:

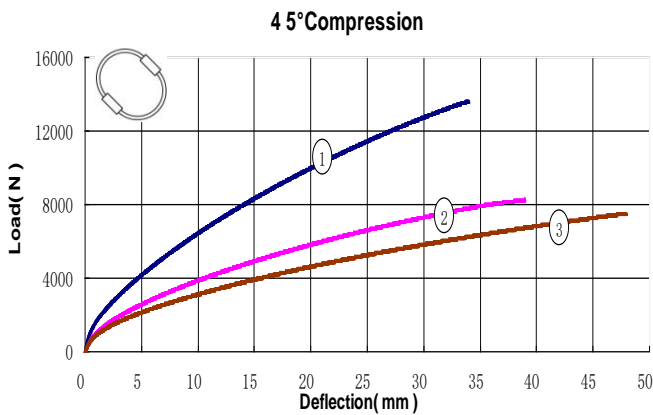

Model	*Load (kg)	**Static Stiffness (N/mm)	Max. Deflection (mm)	Max. Static Load (kg)
GGT430-99	250	677	34	1388
GGT500-109	157	432	39	842
GGT550-119	148	342	48	777

### Shear:

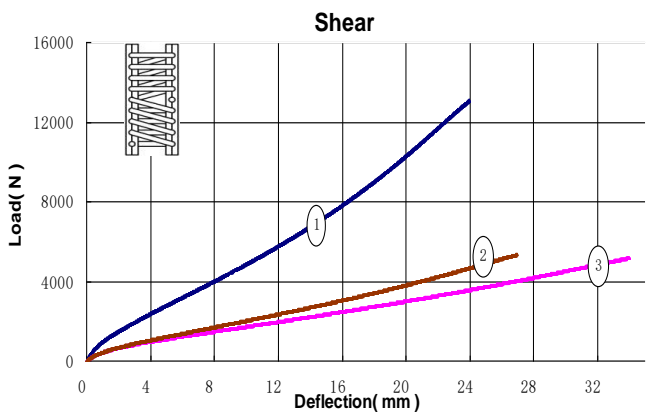

Model	*Load (kg)	**Static Stiffness (N/mm)	Max. Deflection (mm)	Max. Static Load (kg)
GGT430-99	152	461	24	1334
GGT500-109	69	209	27	544
GGT550-119	67	188	34	527

**NOTES:** \* Load --- Static nominal load at 2mm deflection.

\*\* Average Static Stiffness --- Static stiffness at 2mm deflection.

Address: Shuang Xin Industrial Park, TaiHu Town,  
WuXi, P. R. China

Post Code: 214125

Phone: (86-0510) 85192826 85190626

Fax: (86-0510) 85192826 85190626

E-mail: trade@dpflex.com daping369@163.com

Website: <http://www.dpflex.com>

**WUXI HONGYUAN DEVFLEX CO., LTD**

## GGT09 Series Static Load — Deflection Charts:

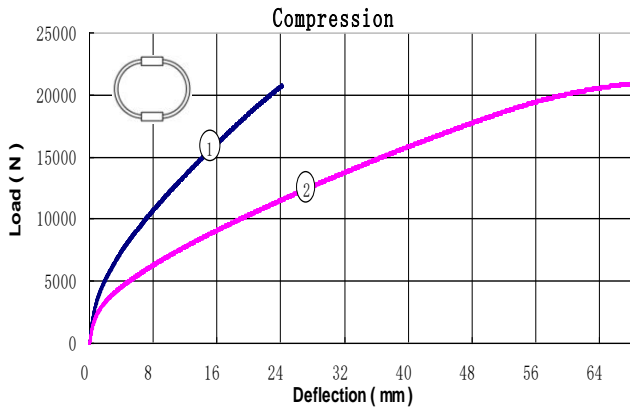

**Compression:**

Model	*Load (kg)	**Static Stiffness (N/mm)	Max. Deflection (mm)	Max. Static Load (kg)
GGT1200-159	529	1301	25	2118
GGT1300-191	346	736	69	2138

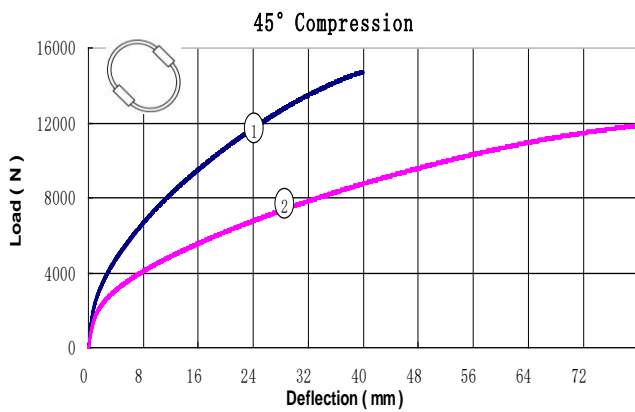

**45° Compression:**

Model	*Load (kg)	**Static Stiffness (N/mm)	Max. Deflection (mm)	Max. Static Load (kg)
GGT1200-159	351	800	40	1501
GGT1300-191	240	489	80	1210

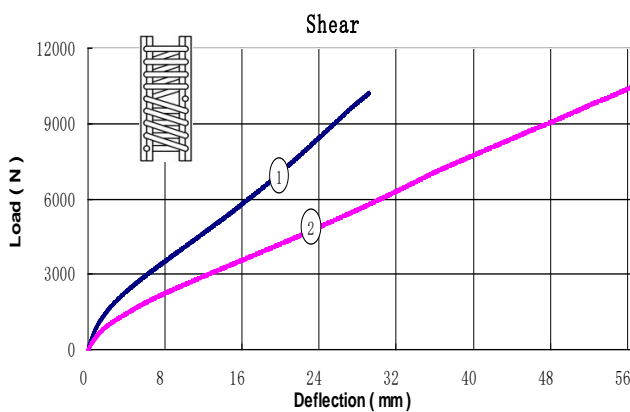

**Shear:**

Model	*Load (kg)	**Static Stiffness (N/mm)	Max. Deflection (mm)	Max. Static Load (kg)
GGT1200-159	160	467	30	1043
GGT1300-191	98	292	57	1073

**NOTES:** \* Load --- Static nominal load at 2mm deflection.

\*\* Average Static Stiffness --- Static stiffness at 2mm deflection.

Address: Shuang Xin Industrial Park, TaiHu Town,  
WuXi, P. R. China

Post Code: 214125

Phone: (86-0510) 85192826 85190626

Fax: (86-0510) 85192826 85190626

E-mail: trade@dpflex.com daping369@163.com

Website: <http://www.dpflex.com>

**WUXI HONGYUAN DEVFLEX CO., LTD**