

GGT SERIES VIBRATION ISOLATORS

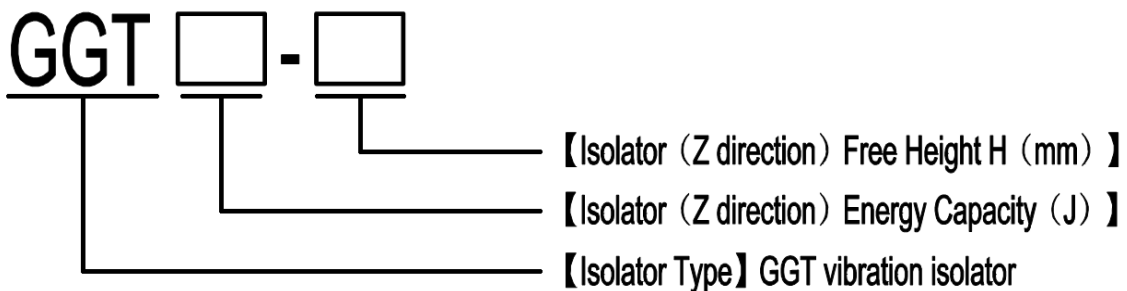

Model Description



NOTES:

- All dimensions are metric (mm).
- Material for retainer bars is 2A12 Aluminum Alloy; wire ropes, hoops and nuts are 304 stainless steel, and inserts (if with) are 304 stainless steel.
- Operating temperature range: $-100^{\circ}\text{C} \sim +250^{\circ}\text{C}$.
- Standard product retainer bars are anodized.
- Standard product mounting holes are metric.
- Specials available upon request.

Technical Data:

Address: Shuang Xin Industrial Park, TaiHu Town,
WuXi, P. R. China

Post Code: 214125

Phone: (86-0510) 85192826 85190626

Fax: (86-0510) 85192826 85190626

E-mail: trade@dpflex.com daping369@163.com

Website: <http://www.dpflex.com>

WUXI HONGYUAN DEVFLEX CO., LTD

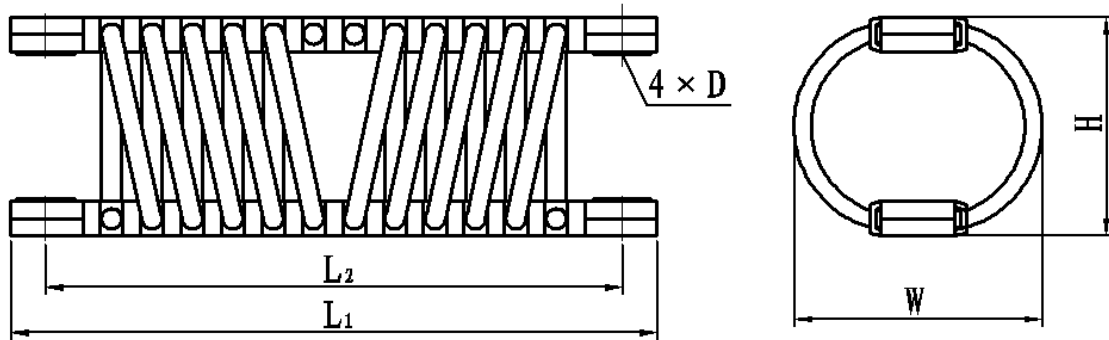

Product Dimensions:

| Model | L1 (mm) | L2 (mm) | Width W (mm) | Height H (mm) | Mounting Holes D | Weight (kg) |
|------------|------------|------------|-----------------|------------------|---------------------|----------------|
| GGT0.59-20 | 80 | 69 | 28 | 20 | M4 | 0.03 |
| GGT0.64-25 | | | 30 | 25 | | 0.032 |
| GGT0.58-33 | | | 38 | 33 | | 0.036 |
| GGT2.1-23 | 112 | 100 | 28 | 23 | M5 | 0.08 |
| GGT2.8-33 | | | 38 | 33 | | 0.09 |
| GGT2.3-38 | | | 43 | 38 | | 0.09 |
| GGT3.9-30 | 128 | 116 | 38 | 30 | M6 | 0.09 |
| GGT4.6-33 | | | 41 | 33 | | 0.1 |
| GGT5.3-36 | | | 43 | 36 | | 0.12 |
| GGT4.3-41 | | | 48 | 41 | | 0.13 |
| GGT11-38 | 128 | 116 | 43 | 38 | | 0.22 |
| GGT12-41 | | | 46 | 41 | | 0.22 |
| GGT9.5-45 | | | 50 | 45 | | 0.24 |

GGT01 Series Static Load — Deflection Charts:

Address: Shuang Xin Industrial Park, TaiHu Town,
WuXi, P. R. China

Post Code: 214125

Phone: (86-0510) 85192826 85190626

Fax: (86-0510) 85192826 85190626

E-mail: trade@dpflex.com daping369@163.com

Website: <http://www.dpflex.com>

WUXI HONGYUAN DEVFLEX CO., LTD

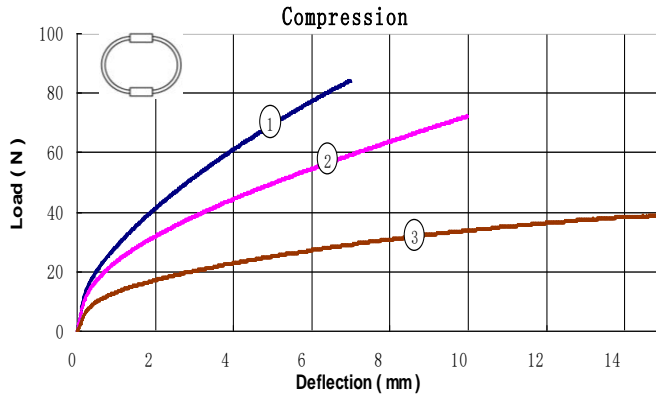
**Compression:**

| Model | *Load (kg) | **Static Stiffness (N/mm) | Max. Deflection (mm) | Max. Static Load (kg) |
|------------|------------|---------------------------|----------------------|-----------------------|
| GGT0.59-20 | 4.2 | 11.8 | 7 | 8.6 |
| GGT0.64-25 | 3.3 | 7.2 | 10 | 7.4 |
| GGT0.58-33 | 1.7 | 3.6 | 15 | 4 |

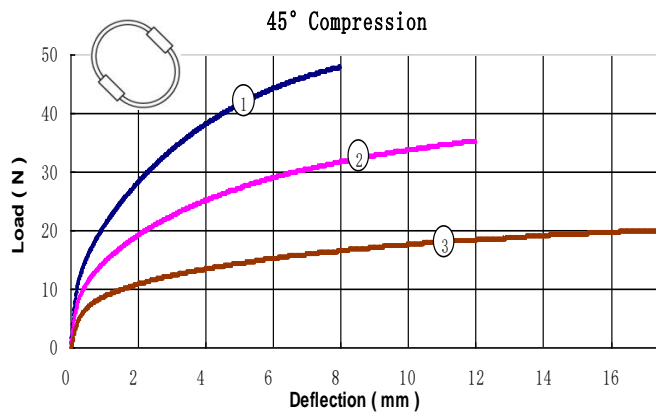
**45° Compression:**

| Model | *Load (kg) | **Static Stiffness (N/mm) | Max. Deflection (mm) | Max. Static Load (kg) |
|------------|------------|---------------------------|----------------------|-----------------------|
| GGT0.59-20 | 2.9 | 6.3 | 8 | 4.9 |
| GGT0.64-25 | 2 | 4 | 12 | 3.6 |
| GGT0.58-33 | 1.1 | 1.5 | 18 | 2.1 |

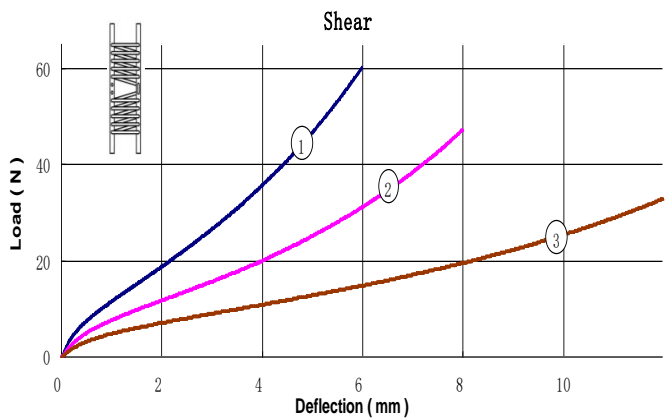
**Shear:**

| Model | *Load (kg) | **Static Stiffness (N/mm) | Max. Deflection (mm) | Max. Static Load (kg) |
|------------|------------|---------------------------|----------------------|-----------------------|
| GGT0.59-20 | 1.9 | 7.2 | 6 | 6.1 |
| GGT0.64-25 | 1.2 | 3.6 | 8 | 4.8 |
| GGT0.58-33 | 0.7 | 1.6 | 12 | 3.4 |

NOTES: * Load --- Static nominal load at 2mm deflection.

** Average Static Stiffness --- Static stiffness at 2mm deflection.

GGT02 Series Static Load — Deflection Charts:

Address: Shuang Xin Industrial Park, TaiHu Town,
WuXi, P. R. China

Post Code: 214125

Phone: (86-0510) 85192826 85190626

Fax: (86-0510) 85192826 85190626

E-mail: trade@dpflex.com daping369@163.com

Website: <http://www.dpflex.com>

WUXI HONGYUAN DEVFLEX CO., LTD

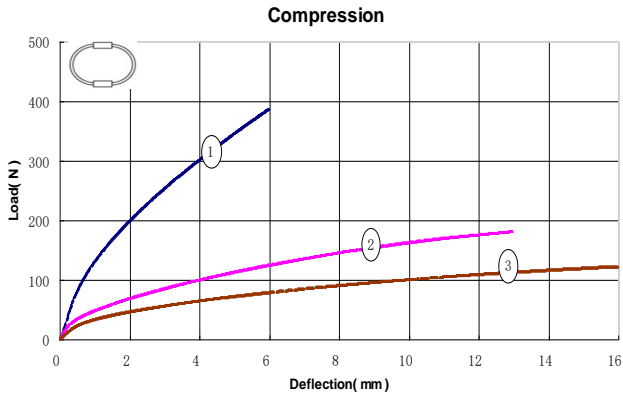
**Compression:**

| Model | *Load (kg) | **Static Stiffness (N/mm) | Max. Deflection (mm) | Max. Static Load (kg) |
|------------|------------|---------------------------|----------------------|-----------------------|
| GGT2. 1-23 | 20.5 | 59.7 | 6 | 40.6 |
| GGT2. 8-33 | 7.1 | 18.2 | 13 | 18.6 |
| GGT2. 3-38 | 4.8 | 10.7 | 16 | 12.6 |

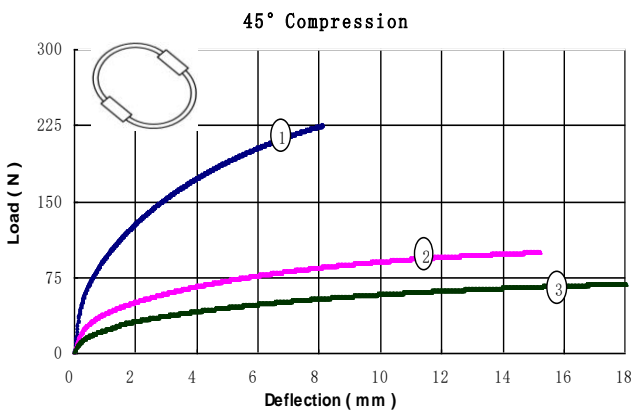
**45° Compression:**

| Model | *Load (kg) | **Static Stiffness (N/mm) | Max. Deflection (mm) | Max. Static Load (kg) |
|------------|------------|---------------------------|----------------------|-----------------------|
| GGT2. 1-23 | 13.1 | 28.6 | 8 | 23 |
| GGT2. 8-33 | 5.2 | 9.8 | 15 | 10.2 |
| GGT2. 3-38 | 3.1 | 6.4 | 18 | 7 |

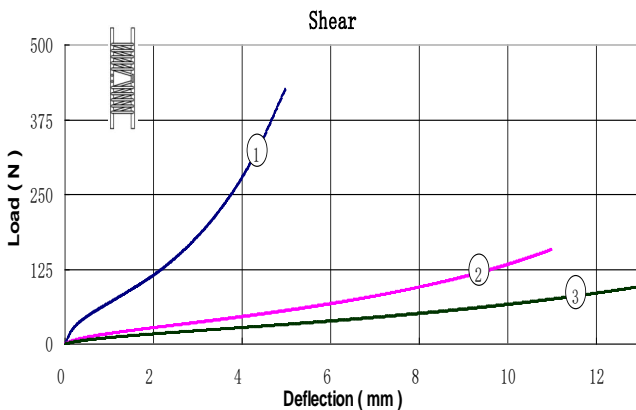
**Shear:**

| Model | *Load (kg) | **Static Stiffness (N/mm) | Max. Deflection (mm) | Max. Static Load (kg) |
|------------|------------|---------------------------|----------------------|-----------------------|
| GGT2. 1-23 | 11.9 | 53.2 | 5 | 43.5 |
| GGT2. 8-33 | 2.8 | 9.1 | 11 | 16.1 |
| GGT2. 3-38 | 1.8 | 5.7 | 13 | 9.8 |

NOTES: * Load --- Static nominal load at 2mm deflection.

** Average Static Stiffness --- Static stiffness at 2mm deflection.

GGT03 Series Static Load — Deflection Charts:

Address: Shuang Xin Industrial Park, TaiHu Town,
WuXi, P. R. China

Post Code: 214125

Phone: (86-0510) 85192826 85190626

Fax: (86-0510) 85192826 85190626

E-mail: trade@dpflex.com daping369@163.com

Website: <http://www.dpflex.com>

WUXI HONGYUAN DEVFLEX CO., LTD

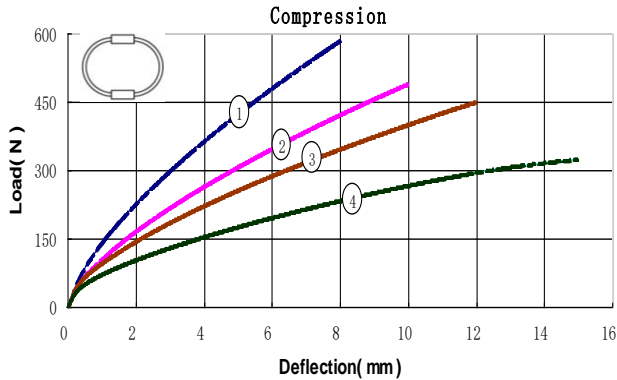
Compression:

| Model | *Load (kg) | **Static Stiffness (N/mm) | Max. Deflection (mm) | Max. Static Load (kg) |
|------------|------------|---------------------------|----------------------|-----------------------|
| GGT3. 9-30 | 23.3 | 77 | 8 | 59.7 |
| GGT4. 6-33 | 17.1 | 52 | 10 | 49.9 |
| GGT5. 3-36 | 14.8 | 43.4 | 12 | 45.9 |
| GGT4. 3-41 | 10.6 | 29.1 | 15 | 33.2 |

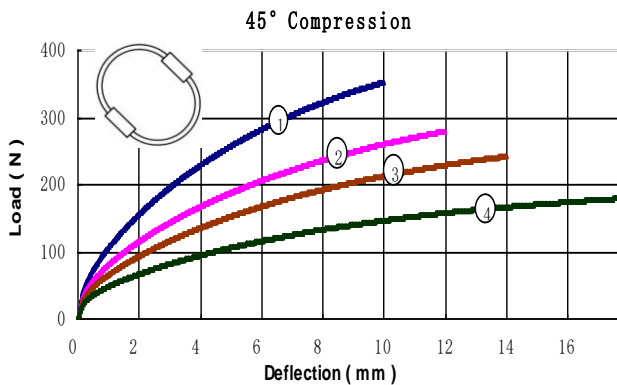
45° Compression:

| Model | *Load (kg) | **Static Stiffness (N/mm) | Max. Deflection (mm) | Max. Static Load (kg) |
|------------|------------|---------------------------|----------------------|-----------------------|
| GGT3. 9-30 | 16 | 45.3 | 10 | 36 |
| GGT4. 6-33 | 11.8 | 28.7 | 12 | 28.6 |
| GGT5. 3-36 | 9.6 | 25.9 | 14 | 24.7 |
| GGT4. 3-41 | 6.9 | 14.3 | 18 | 18.4 |

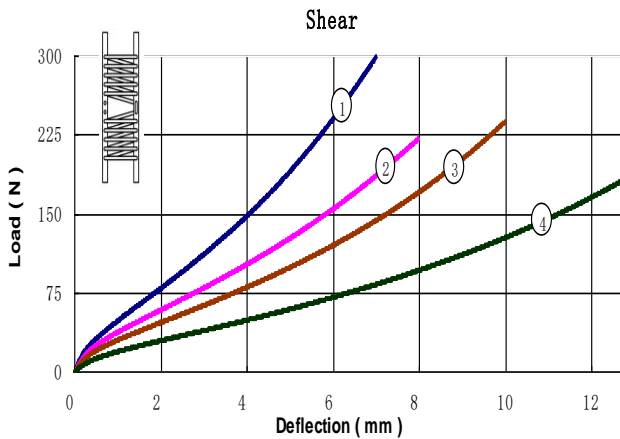
Shear:

| Model | *Load (kg) | **Static Stiffness (N/mm) | Max. Deflection (mm) | Max. Static Load (kg) |
|------------|------------|---------------------------|----------------------|-----------------------|
| GGT3. 9-30 | 8.2 | 31.1 | 7 | 30.6 |
| GGT4. 6-33 | 6.1 | 19.4 | 8 | 22.7 |
| GGT5. 3-36 | 4.8 | 14.4 | 10 | 24.3 |
| GGT4. 3-41 | 3.1 | 10.2 | 13 | 19.2 |

NOTES: * Load --- Static nominal load at 2mm deflection.

** Average Static Stiffness --- Static stiffness at 2mm deflection.

GGT04 Series Static Load — Deflection Charts:

Address: Shuang Xin Industrial Park, TaiHu Town,
WuXi, P. R. China

Post Code: 214125

Phone: (86-0510) 85192826 85190626

Fax: (86-0510) 85192826 85190626

E-mail: trade@dpflex.com daping369@163.com

Website: <http://www.dpflex.com>

WUXI HONGYUAN DEVFLEX CO., LTD

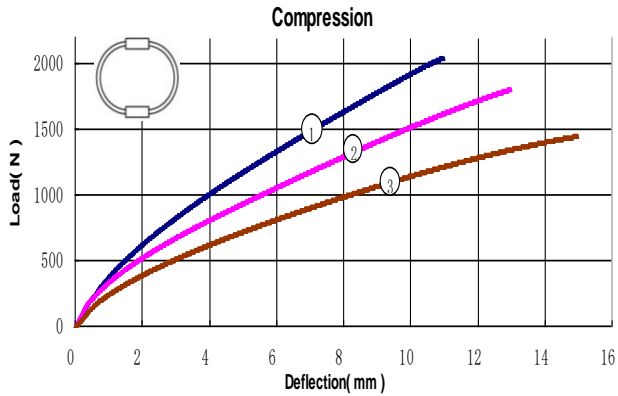
**Compression:**

| Model | *Load (kg) | **Static Stiffness (N/mm) | Max. Deflection (mm) | Max. Static Load (kg) |
|-----------|------------|---------------------------|----------------------|-----------------------|
| GGT11-38 | 70.4 | 227.6 | 11 | 208.9 |
| GGT12-41 | 53.2 | 163.2 | 13 | 184.2 |
| GGT9.5-45 | 39.8 | 130.2 | 15 | 147.8 |

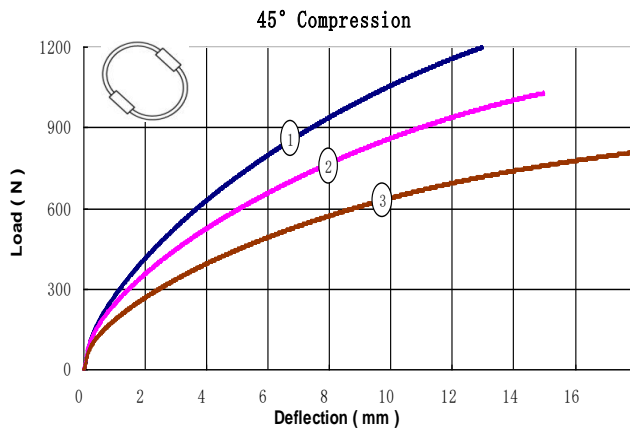
**45° Compression:**

| Model | *Load (kg) | **Static Stiffness (N/mm) | Max. Deflection (mm) | Max. Static Load (kg) |
|-----------|------------|---------------------------|----------------------|-----------------------|
| GGT11-38 | 42.6 | 123.7 | 13 | 122.4 |
| GGT12-41 | 36.5 | 99 | 15 | 105 |
| GGT9.5-45 | 27.6 | 74.7 | 18 | 82.7 |

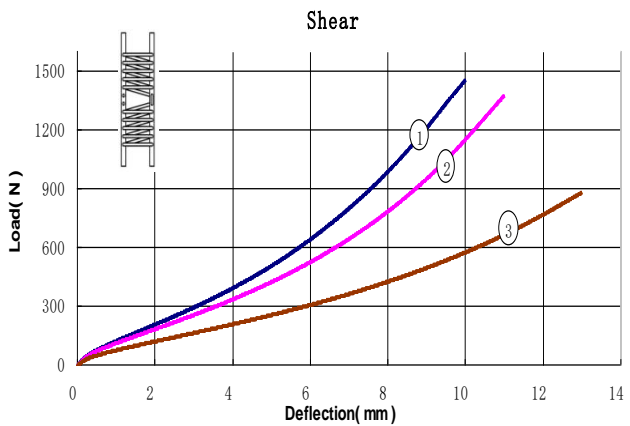
**Shear:**

| Model | *Load (kg) | **Static Stiffness (N/mm) | Max. Deflection (mm) | Max. Static Load (kg) |
|-----------|------------|---------------------------|----------------------|-----------------------|
| GGT11-38 | 21.2 | 85 | 10 | 148.3 |
| GGT12-41 | 18.9 | 69.2 | 11 | 140.4 |
| GGT9.5-45 | 12.4 | 46 | 13 | 89.8 |

NOTES: * Load --- Static nominal load at 2mm deflection.

** Average Static Stiffness --- Static stiffness at 2mm deflection.

Address: Shuang Xin Industrial Park, TaiHu Town,
WuXi, P. R. China

Post Code: 214125

Phone: (86-0510) 85192826 85190626

Fax: (86-0510) 85192826 85190626

E-mail: trade@dpflex.com daping369@163.com

Website: <http://www.dpflex.com>

WUXI HONGYUAN DEVFLEX CO., LTD