

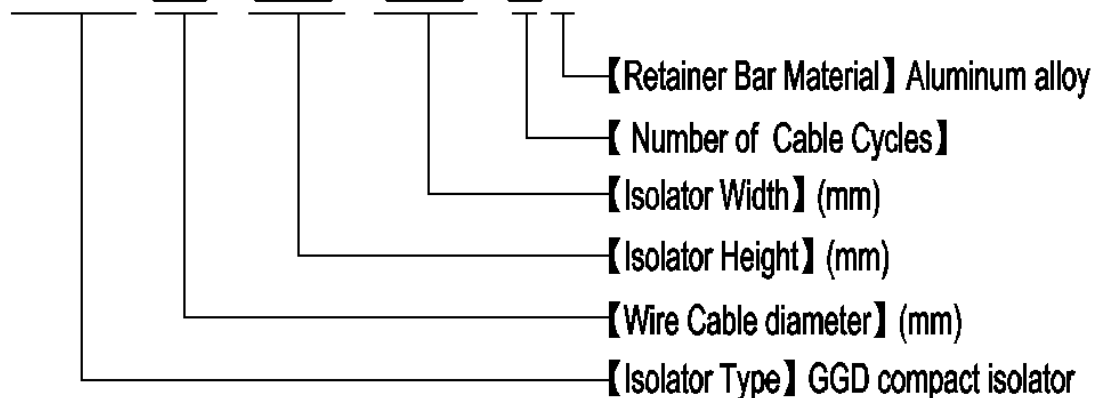

Model Description

GGD □ - □ / □ / □ L



NOTES:

- All dimensions are metric (mm).
- Material for retainer bars is 6061-T6 Aluminum Alloy, wire ropes are 304 stainless steel, and inserts (if with) are 304 stainless steel.
- Operating temperature range: $-100^{\circ}\text{C} \sim +250^{\circ}\text{C}$.
- Standard product retainer bars are hard anodized.
- Standard product mounting holes are metric.
- Specials available upon request.

Address: Shuang Xin Industrial Park, TaiHu Town.
WuXi, P. R. China

Post Code: 214125

Phone: (86-0510) 85192826 85190626

Fax: (86-0510) 85192826 85190626

E-mail: trade@dpflex.com daping369@163.com

Website: <http://www.dpflex.com>

WUXI HONGYUAN DEVFLEX CO., LTD

Technical Data:

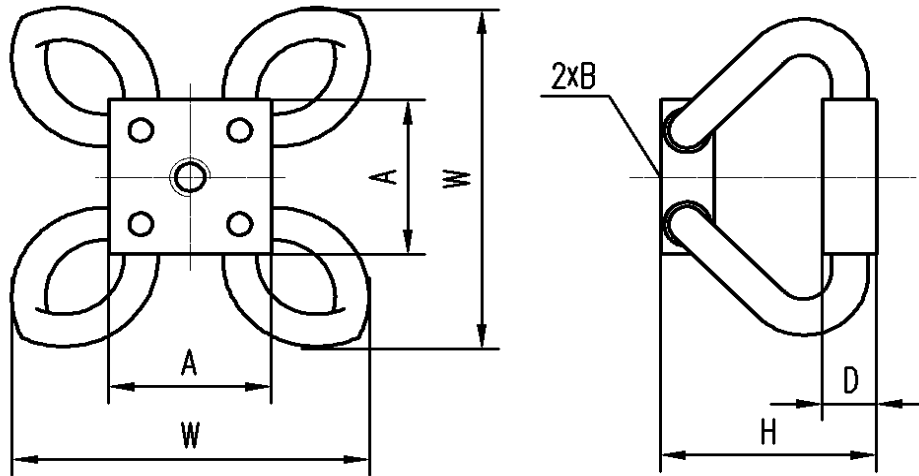

Product Dimensions:

| Model | Width W (mm) | Height H (mm) | Mounting Holes B | A (mm) | D (mm) | Weight (g) |
|---------------------|--------------|---------------|------------------|--------|--------|------------|
| GGD1.6-11.2/17.8/4L | 17.8 | 11.2 | M3 | 10 | 3.5 | 2.8 |
| GGD1.6-12.7/19.8/4L | 19.8 | 12.7 | | | | 2.9 |
| GGD1.6-15.7/21.3/4L | 21.3 | 15.7 | | | | 3.1 |
| GGD2.4-17.8/25.4/4L | 25.4 | 17.8 | M4 | 14 | 5 | 8 |
| GGD2.4-21.6/27.9/4L | 27.9 | 21.6 | | | | 9 |
| GGD2.4-25.4/31.8/4L | 31.8 | 25.4 | | | | 10 |
| GGD3.2-22.9/31.8/4L | 31.8 | 22.9 | M5 | 18 | 6.5 | 16 |
| GGD3.2-25.4/34.3/4L | 34.3 | 25.4 | | | | 17 |
| GGD3.2-27.9/38.1/4L | 38.1 | 27.9 | | | | 19 |
| GGD4.0-25.4/41.9/4L | 41.9 | 25.4 | | 20 | 8 | 28 |
| GGD4.0-30.5/47.0/4L | 47 | 30.5 | | | | 31 |
| GGD4.0-36.8/50.8/4L | 50.8 | 36.8 | 33 | | | |

Address: Shuang Xin Industrial Park, TaiHu Town.
WuXi, P. R. China

Post Code: 214125

Phone: (86-0510) 85192826 85190626

Fax: (86-0510) 85192826 85190626

E-mail: trade@dpflex.com daping369@163.com

Website: <http://www.dpflex.com>

WUXI HONGYUAN DEVFLEX CO., LTD

GGD1.6 Series Static Load — Deflection Charts:

Compression:

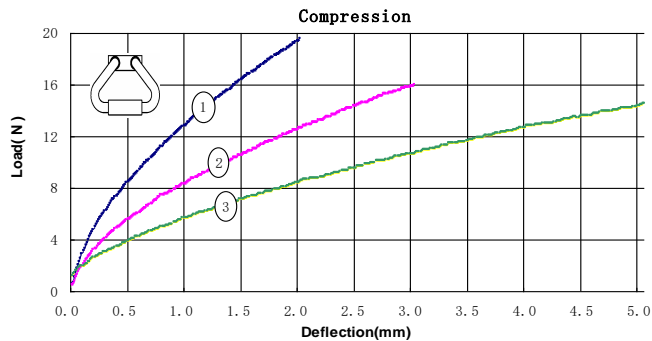

| Model | *Load (kg) | **Static Stiffness (N/mm) | Max. Deflection (mm) | Max. Static Load (kg) |
|---------------------|------------|---------------------------|----------------------|-----------------------|
| GGD1.6-11.2/17.8/4L | 1.9 | 5.7 | 2 | 1.9 |
| GGD1.6-12.7/19.8/4L | 1.3 | 3.5 | 3 | 1.6 |
| GGD1.6-15.7/21.3/4L | 0.9 | 2.4 | 5 | 1.5 |

45° Compression:

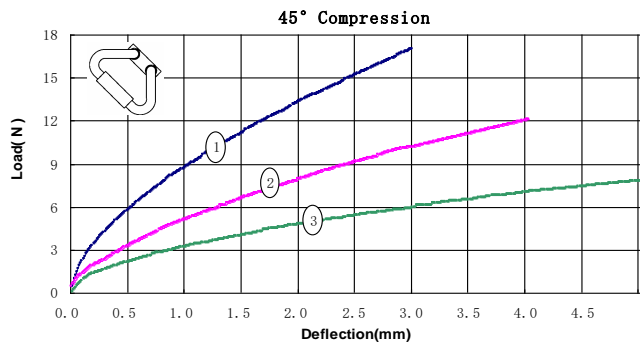

| Model | *Load (kg) | **Static Stiffness (N/mm) | Max. Deflection (mm) | Max. Static Load (kg) |
|---------------------|------------|---------------------------|----------------------|-----------------------|
| GGD1.6-11.2/17.8/4L | 1.3 | 3.9 | 3 | 1.7 |
| GGD1.6-12.7/19.8/4L | 0.8 | 2.5 | 4 | 1.2 |
| GGD1.6-15.7/21.3/4L | 0.4 | 1.2 | 5 | 0.8 |

Shear:

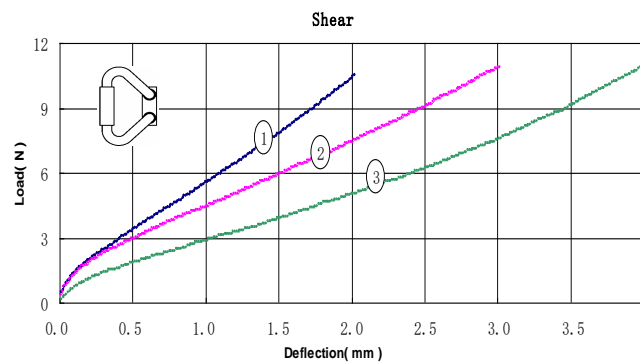

| Model | *Load (kg) | **Static Stiffness (N/mm) | Max. Deflection (mm) | Max. Static Load (kg) |
|---------------------|------------|---------------------------|----------------------|-----------------------|
| GGD1.6-11.2/17.8/4L | 1 | 5.5 | 2 | 1 |
| GGD1.6-12.7/19.8/4L | 0.7 | 3.1 | 3 | 1.1 |
| GGD1.6-15.7/21.3/4L | 0.5 | 2.3 | 4 | 1.1 |

NOTES: * Load --- Static nominal load at 2mm deflection.
 ** Average Static Stiffness --- Static stiffness at 2mm deflection.

Address: Shuang Xin Industrial Park, TaiHu Town.
 WuXi, P. R. China

Post Code: 214125

Phone: (86-0510) 85192826 85190626

Fax: (86-0510) 85192826 85190626

E-mail: trade@dpflex.com daping369@163.com

Website: <http://www.dpflex.com>

WUXI HONGYUAN DEVFLEX CO., LTD

GGD2.4 Series Static Load — Deflection Charts:

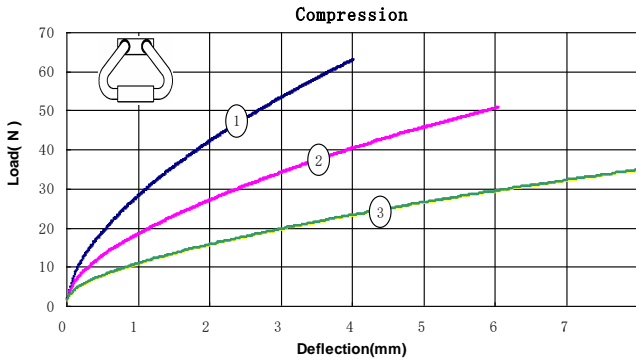

Compression:

| Model | *Load (kg) | **Static Stiffness (N/mm) | Max. Deflection (mm) | Max. Static Load (kg) |
|---------------------|------------|---------------------------|----------------------|-----------------------|
| GGD2.4-17.8/25.4/4L | 4.3 | 11.9 | 4 | 6.4 |
| GGD2.4-21.6/27.9/4L | 2.7 | 7.6 | 6 | 5.1 |
| GGD2.4-25.4/31.8/4L | 1.6 | 3.8 | 8 | 3.5 |

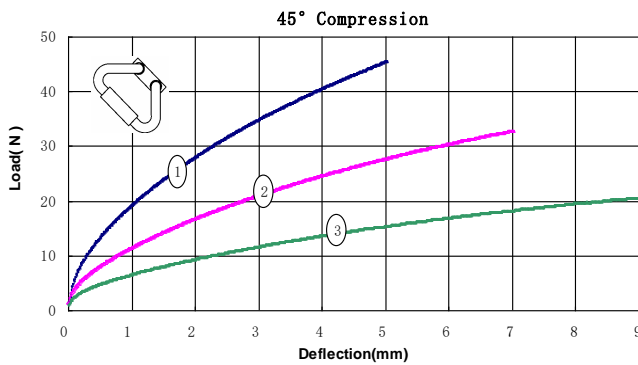

45° Compression:

| Model | *Load (kg) | **Static Stiffness (N/mm) | Max. Deflection (mm) | Max. Static Load (kg) |
|---------------------|------------|---------------------------|----------------------|-----------------------|
| GGD2.4-17.8/25.4/4L | 2.8 | 7.7 | 5 | 4.6 |
| GGD2.4-21.6/27.9/4L | 1.7 | 4.7 | 7 | 3.3 |
| GGD2.4-25.4/31.8/4L | 0.9 | 2.5 | 9 | 2.1 |

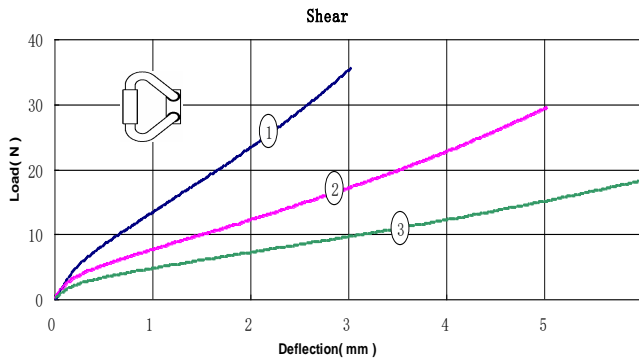

Shear:

| Model | *Load (kg) | **Static Stiffness (N/mm) | Max. Deflection (mm) | Max. Static Load (kg) |
|---------------------|------------|---------------------------|----------------------|-----------------------|
| GGD2.4-17.8/25.4/4L | 2.3 | 10.5 | 3 | 3.6 |
| GGD2.4-21.6/27.9/4L | 1.2 | 4.6 | 5 | 3 |
| GGD2.4-25.4/31.8/4L | 0.7 | 2.4 | 6 | 1.8 |

NOTES: * Load --- Static nominal load at 2mm deflection.
 ** Average Static Stiffness --- Static stiffness at 2mm deflection.

Address: Shuang Xin Industrial Park, TaiHu Town.
 WuXi, P. R. China
 Post Code: 214125
 Phone: (86-0510) 85192826 85190626
 Fax: (86-0510) 85192826 85190626
 E-mail: trade@dpflex.com daping369@163.com
 Website: <http://www.dpflex.com>

WUXI HONGYUAN DEVFLEX CO., LTD

GGD3.2 Series Static Load — Deflection Charts:

Compression:

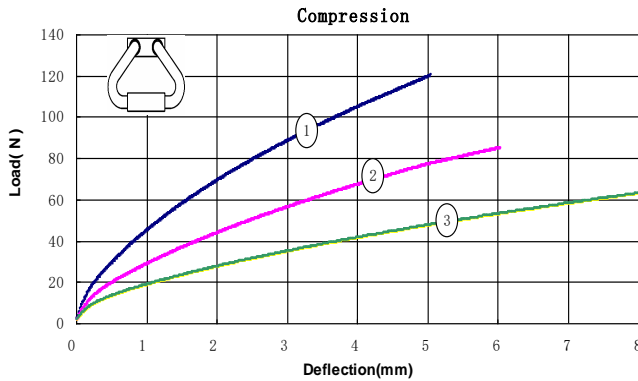

| Model | *Load (kg) | **Static Stiffness (N/mm) | Max. Deflection (mm) | Max. Static Load (kg) |
|---------------------|------------|---------------------------|----------------------|-----------------------|
| GGD3.2-22.9/31.8/4L | 7 | 21.7 | 5 | 12.2 |
| GGD3.2-25.4/34.3/4L | 4.5 | 13.3 | 6 | 8.6 |
| GGD3.2-27.9/38.1/4L | 2.8 | 8 | 8 | 6.4 |

45° Compression:

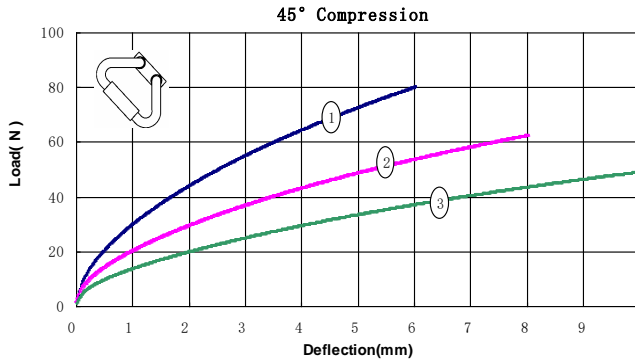

| Model | *Load (kg) | **Static Stiffness (N/mm) | Max. Deflection (mm) | Max. Static Load (kg) |
|---------------------|------------|---------------------------|----------------------|-----------------------|
| GGD3.2-22.9/31.8/4L | 4.5 | 12.4 | 6 | 8.1 |
| GGD3.2-25.4/34.3/4L | 3 | 8.15 | 8 | 6.3 |
| GGD3.2-27.9/38.1/4L | 2 | 5.5 | 10 | 4.9 |

Shear:

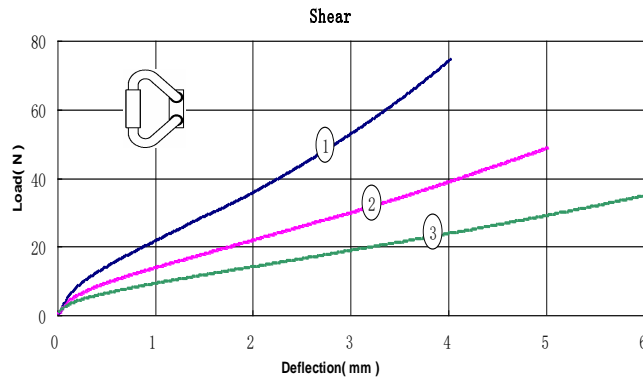

| Model | *Load (kg) | **Static Stiffness (N/mm) | Max. Deflection (mm) | Max. Static Load (kg) |
|---------------------|------------|---------------------------|----------------------|-----------------------|
| GGD3.2-22.9/31.8/4L | 3.7 | 15.7 | 4 | 7.6 |
| GGD3.2-25.4/34.3/4L | 2.2 | 7.9 | 5 | 4.9 |
| GGD3.2-27.9/38.1/4L | 1.4 | 4.6 | 6 | 3.5 |

NOTES: * Load --- Static nominal load at 2mm deflection.
 ** Average Static Stiffness --- Static stiffness at 2mm deflection.

Address: Shuang Xin Industrial Park, TaiHu Town.
 WuXi, P. R. China
 Post Code: 214125
 Phone: (86-0510) 85192826 85190626
 Fax: (86-0510) 85192826 85190626
 E-mail: trade@dpflex.com daping369@163.com
 Website: <http://www.dpflex.com>

WUXI HONGYUAN DEVFLEX CO., LTD

GGD4.0 Series Static Load — Deflection Charts:

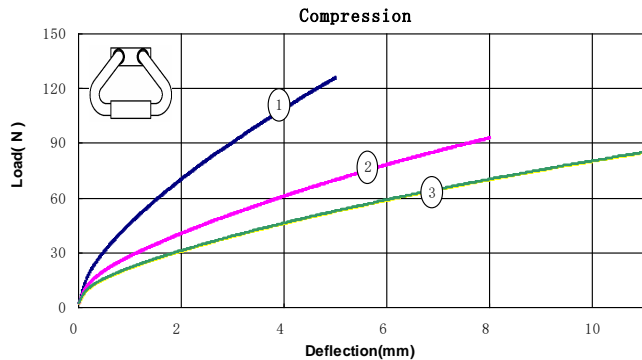

Compression:

| Model | *Load (kg) | **Static Stiffness (N/mm) | Max. Deflection (mm) | Max. Static Load (kg) |
|---------------------|------------|---------------------------|----------------------|-----------------------|
| GGD4.0-25.4/41.9/4L | 7.1 | 21.6 | 5 | 12.8 |
| GGD4.0-30.5/47.0/4L | 4.1 | 11.2 | 8 | 9.4 |
| GGD4.0-36.8/50.8/4L | 3.1 | 8.2 | 11 | 8.6 |

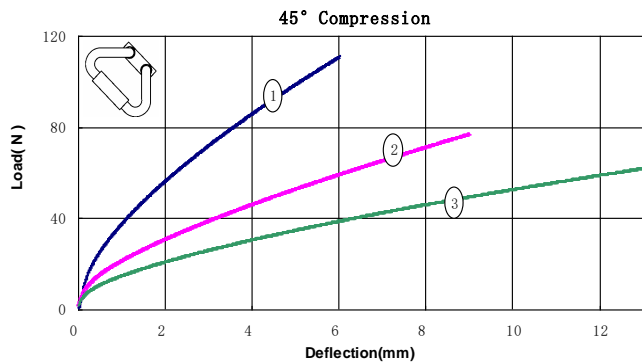

45° Compression:

| Model | *Load (kg) | **Static Stiffness (N/mm) | Max. Deflection (mm) | Max. Static Load (kg) |
|---------------------|------------|---------------------------|----------------------|-----------------------|
| GGD4.0-25.4/41.9/4L | 5.7 | 17.1 | 6 | 11.2 |
| GGD4.0-30.5/47.0/4L | 3.1 | 8.6 | 9 | 7.8 |
| GGD4.0-36.8/50.8/4L | 2.1 | 5.6 | 13 | 6.3 |

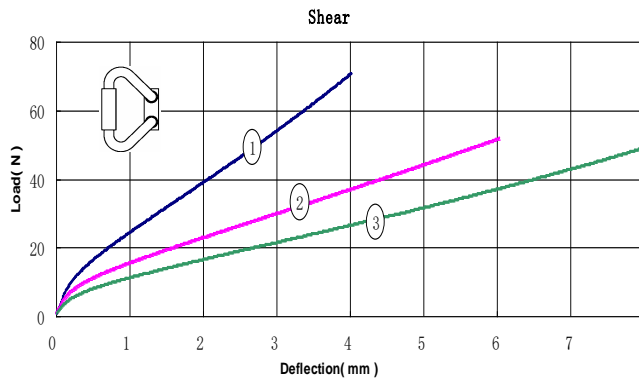

Shear:

| Model | *Load (kg) | **Static Stiffness (N/mm) | Max. Deflection (mm) | Max. Static Load (kg) |
|---------------------|------------|---------------------------|----------------------|-----------------------|
| GGD4.0-25.4/41.9/4L | 3.9 | 14.6 | 4 | 7.2 |
| GGD4.0-30.5/47.0/4L | 2.3 | 6.9 | 6 | 5.2 |
| GGD4.0-36.8/50.8/4L | 1.7 | 5.1 | 8 | 4.9 |

NOTES: * Load --- Static nominal load at 2mm deflection.
 ** Average Static Stiffness --- Static stiffness at 2mm deflection.

Address: Shuang Xin Industrial Park, TaiHu Town.
 WuXi, P. R. China

Post Code: 214125

Phone: (86-0510) 85192826 85190626

Fax: (86-0510) 85192826 85190626

E-mail: trade@dpflex.com daping369@163.com

Website: <http://www.dpflex.com>

WUXI HONGYUAN DEVFLEX CO., LTD